

610/610G Style

- A = height from floor to chimney connection upwards
- B = height from floor to c/c chimney connection rear
- C = height from floor to air inlet
- D = height from floor to lower edge of hatch

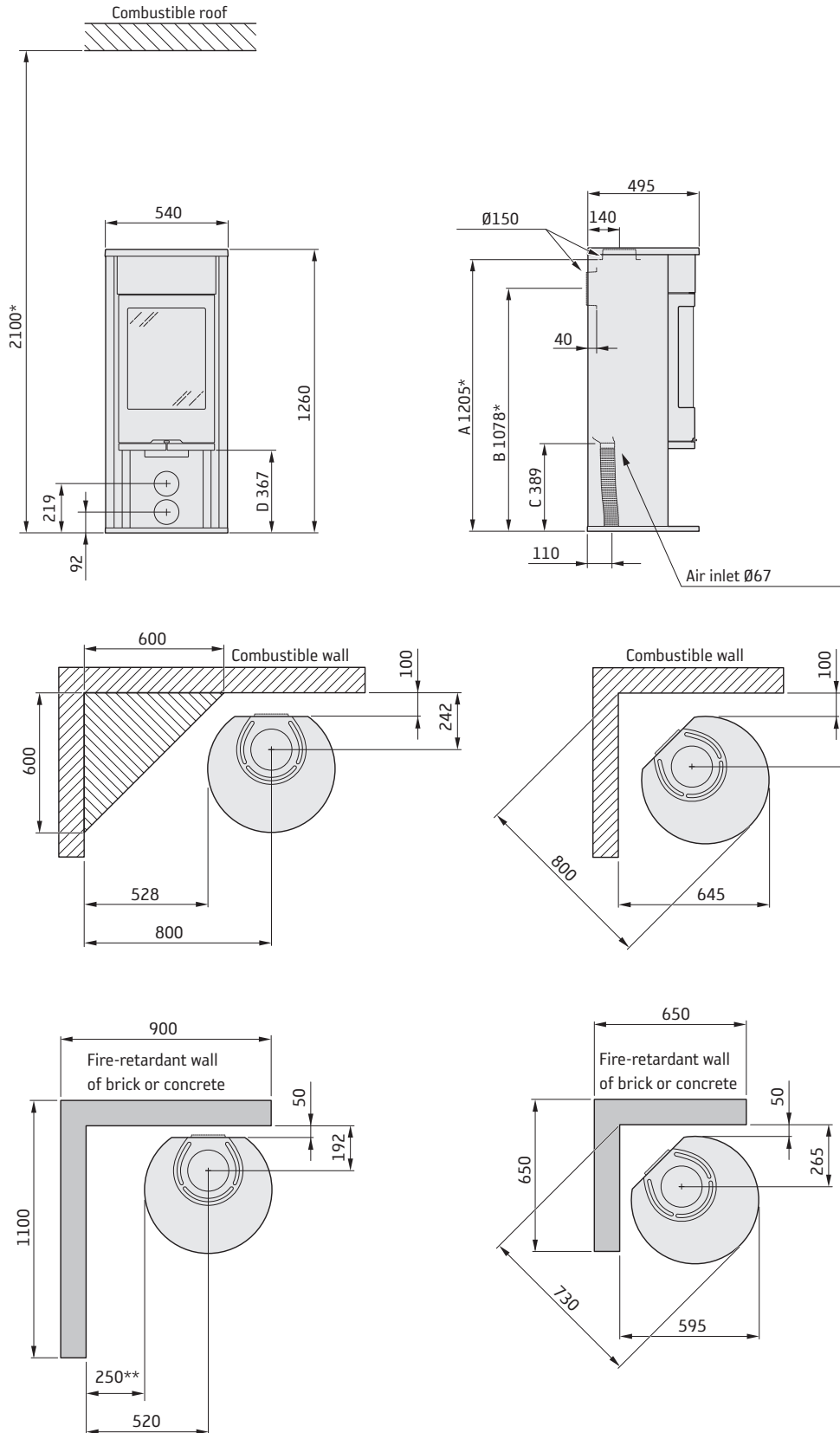

* If the stove is placed on a hearth plate made of glass for example (accessory), the height from the floor is affected by a distance corresponding to the thickness of the hearth plate, for a free standing glass hearth plate this is 10 mm.

** To prevent discolouration of painted non-flammable walls we recommend that the same side distance as to combustible walls is used.